



P H O E N I X

Seating and Tables
2022

#DesignedForLife

Seating and Tables

2022

OUR STORY

The journey of Phoenix begins in **1976**, when an advertisement in the newspaper showcased the sale of a plastic factory. The dying embers of the machinery piqued an interest in **Mr Omar**. He took his son to see the injection molding factory, something neither had ever seen before. Mr. Omar's vision always led him **toward the new and exciting**. After playfully bidding, they acquired not just a factory, but a lifelong business and **passion**. As the machines got refurbished, and other challenges were tackled, a vision for **a new company emerged**. The once dilapidated factory became a household brand, known and adored by every Sri Lankan.

Like a **phoenix rising** from its ashes, the company became a hotspot for **entrepreneurial vision**. It made many valuable partnerships along the way, which have been key contributors to the company's rise today. With over **40 years** of industrial **experience**, Phoenix has expanded exponentially.

For the Omar family, Phoenix has been a guiding light; a springboard for many future successes, ventures and adventures. Phoenix is about resurgence and resilience.



FOR DESIGNED LIFE

Phoenix lives for you.

Our **purpose** is to make every moment of your life **practical, smart, seamless** and **beautiful**. We imagine, create and manufacture **products** envisioning what can give you the **most trust, comfort** and **support** - everything you would look for in a life partner!

Look around, and you'll see we're right there with you. We are a part of your life - we design for life.



CONTENT



06

Seating



70

Tables



SEATING

Memories are a way to hold on to the things you cherish most. A quiet moment with a friend or a big family dinner to celebrate. Some of our greatest joys are experienced sitting down, looking across the room, and seeing familiar faces all around. We combine aesthetic appeal and ergonomic comfort to make your seating area a place where you can seamlessly dip into conversation, creating unforgettable moments.

ENVISION





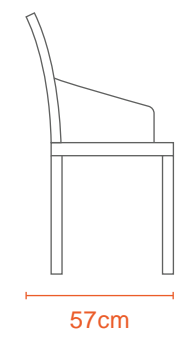
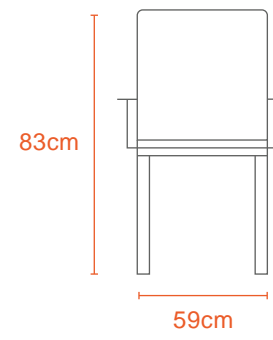
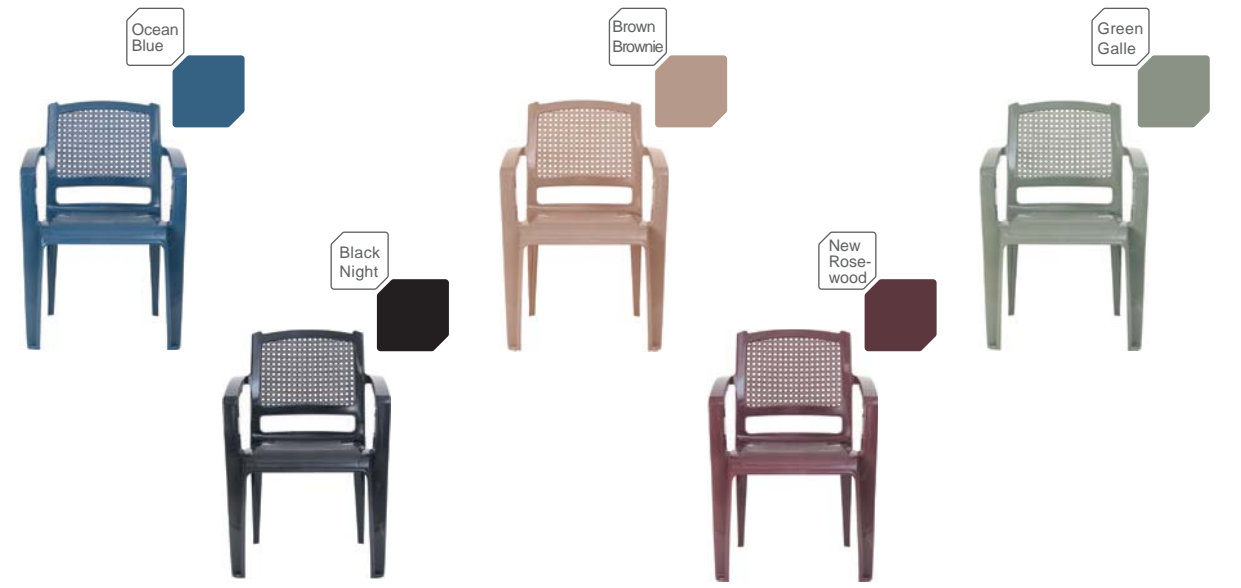

2.1Kg



polypropylene

OLIVIA





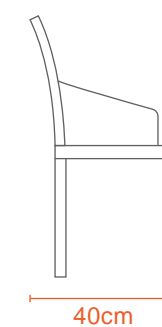
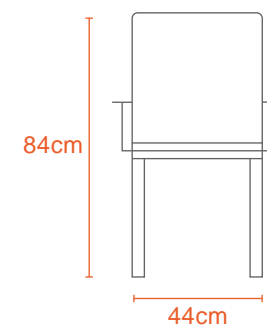



VOGUE



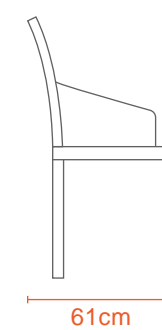
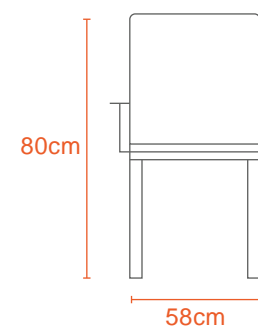

4Kg



Polypropylene



MINT

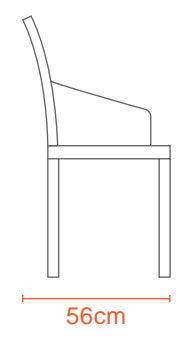
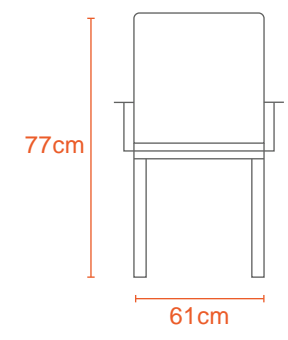

Kg
3.4Kg

Polypropylene

CAMBRIDGE



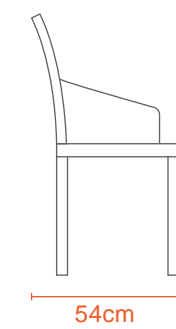
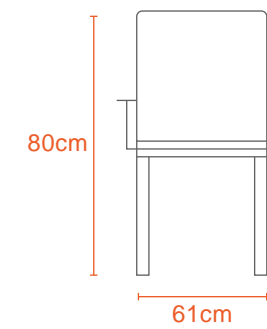
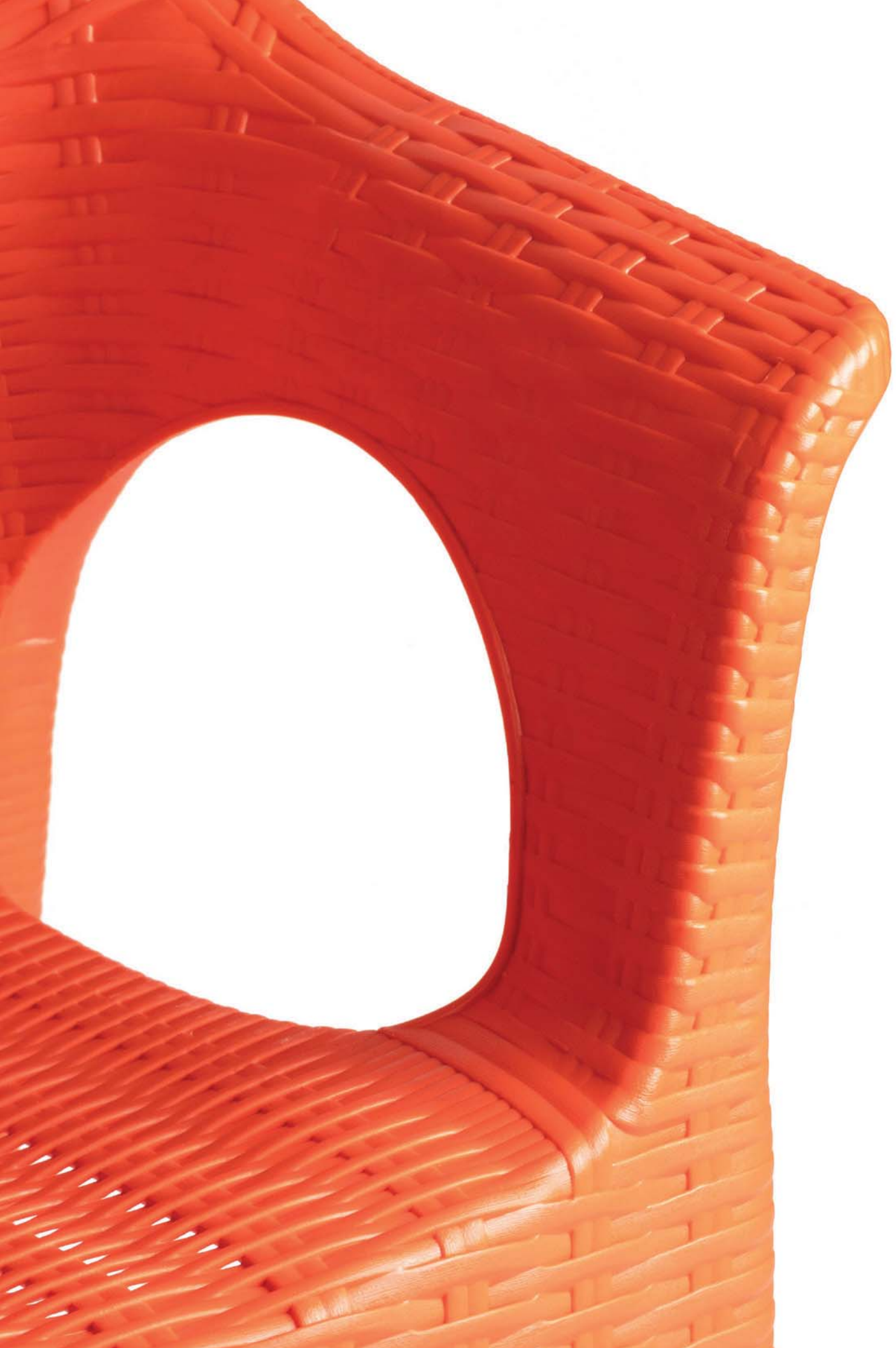

RATTAN

LOW BACK

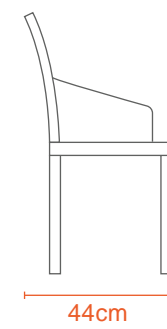
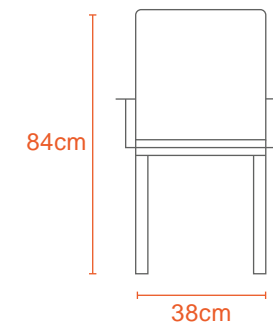
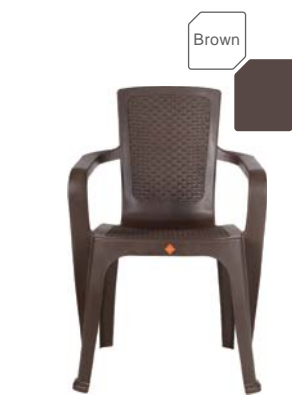

Kg

2.3Kg



Polypropylene

RATTAN

ARMLESS

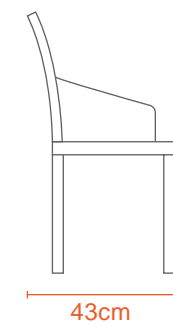
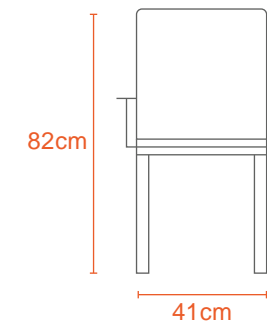

SIGNATURE



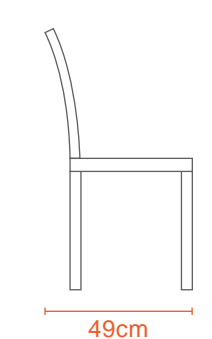
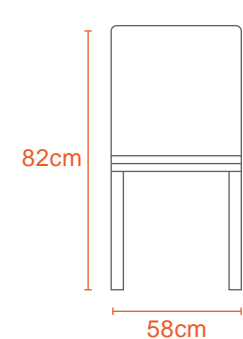



2Kg

Polypropylene

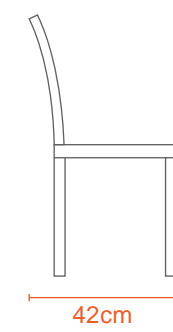
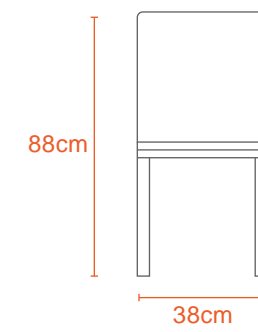

CHAIR BASICS

NELUM



Kg

1.8Kg

Polypropylene

ARMLESS

2011



Wooden
Finish



Rose-
wood

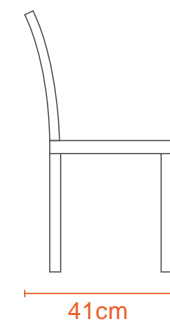
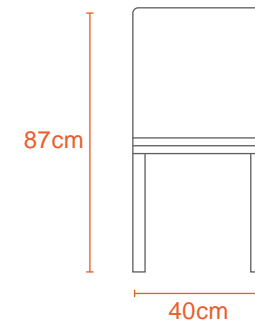

2Kg



Polypropylene

CAFE



Wooden
Finish



Rose-
wood

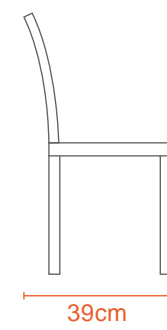
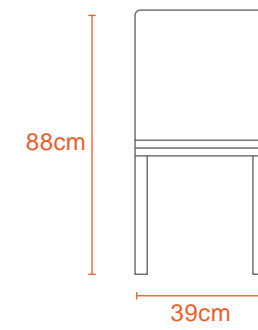

Kg
1.6Kg

Polypropylene

GRAND

ARMLESS

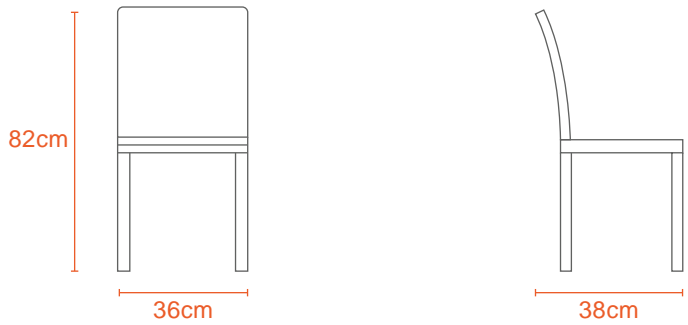

Kg
1.6Kg

Polypropylene

ELITE

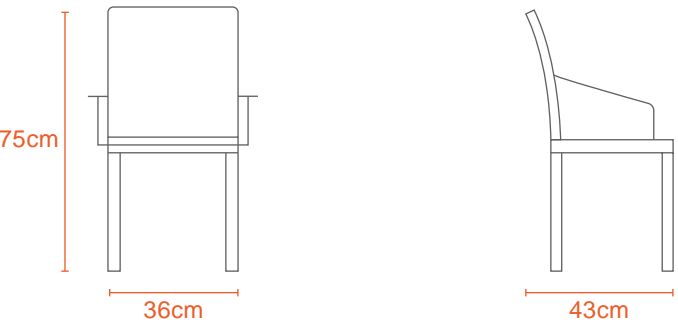

Kg
1.7Kg

Polypropylene

VISION

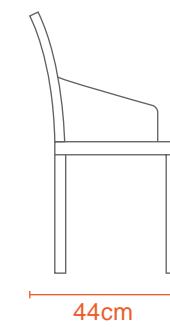
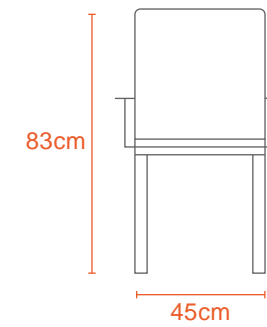

DELUX

LOW BACK

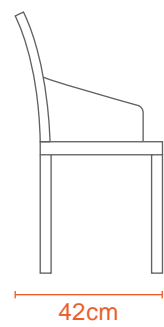
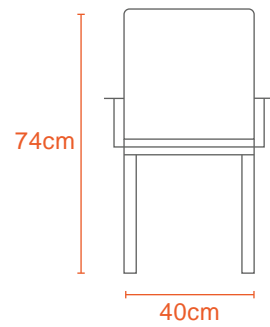
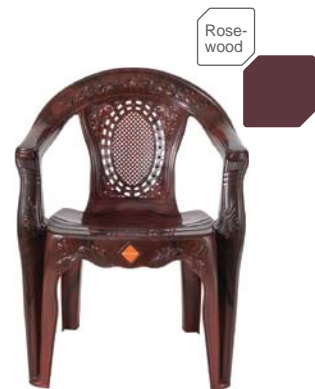

1.7Kg



Polypropylene

DAISY

LOW BACK

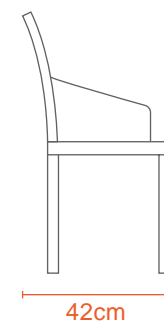
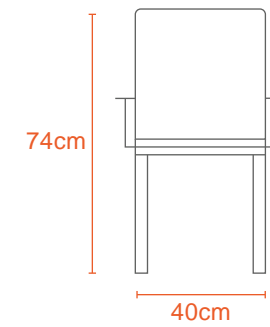

1.7Kg



Polypropylene

AUDITORIUM

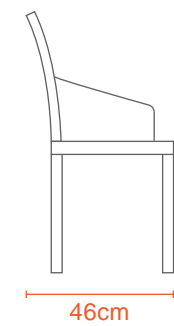
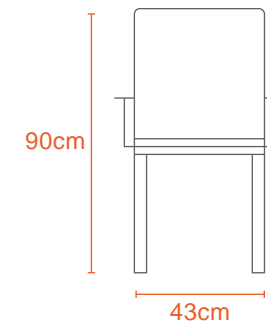
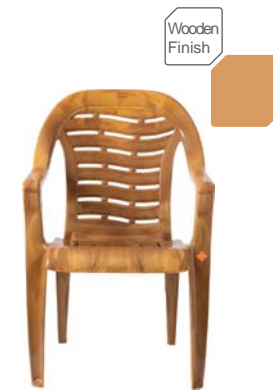

Kg
3Kg

Polypropylene

SOFA



Black



Wooden Finish



Rose-wood

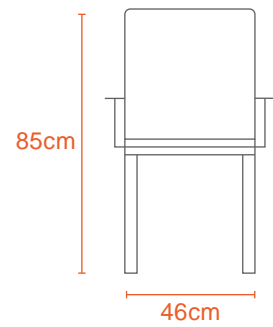

46cm



Kg

3Kg

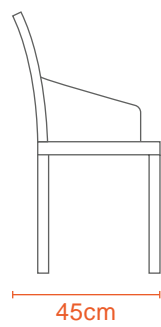

45cm



Polypropylene

VINTAGE

HIGH BACK



Black



Wooden Finish



Rose-wood

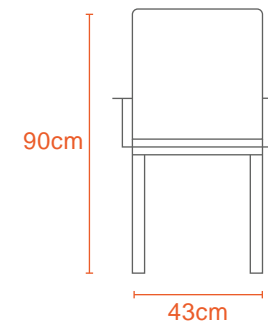

43cm



Kg

2.6Kg

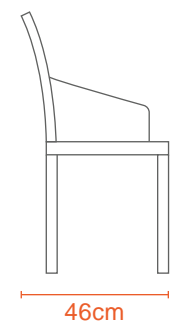

46cm



Polypropylene

COMFORT

SUNNY

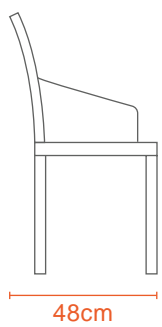
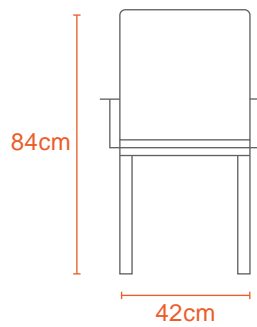



Kg
3Kg

Polypropylene

PACIFIC

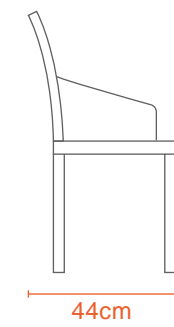
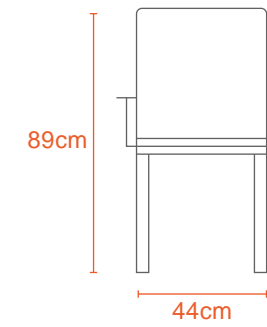
MEDIUM BACK





2.5Kg

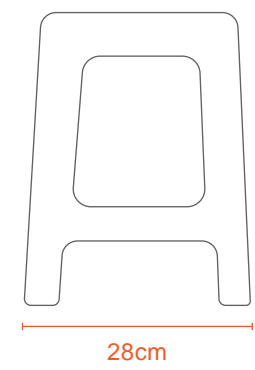
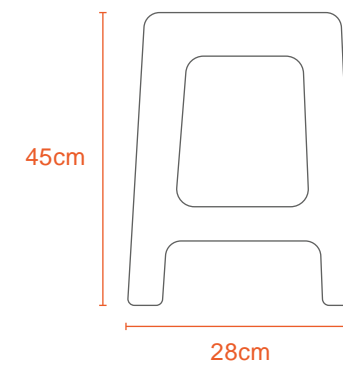

Polypropylene

RATTAN STOOL



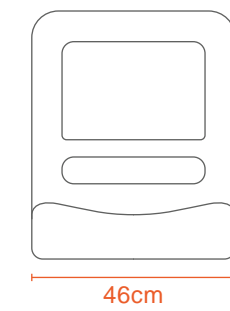
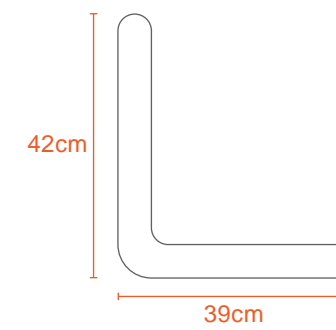

STADIUM I



Kg

2.4Kg



Polyethylene

STADIUM II

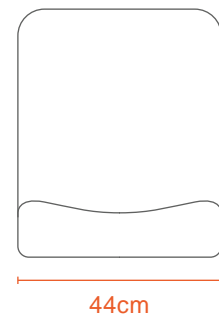
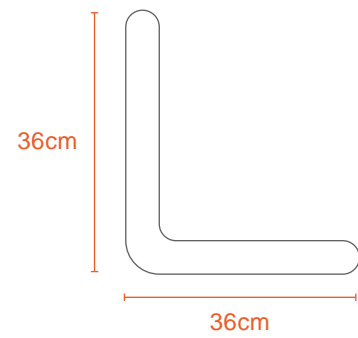

BENCH

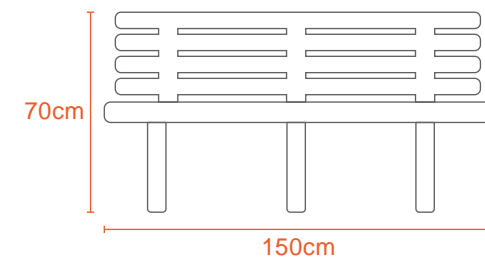



TABLES

A table is a meeting point; a piece of furniture that has the ability to be both static and moving at the same time. Some of our most special moments, happen in those quiet and contemplative moments surrounding a table. Announcements, celebrations, heartbreaks, milestones, whatever it is, let our tables be there for you. We create tables that blend into every home and transform themselves for all your needs.

6 SEATER

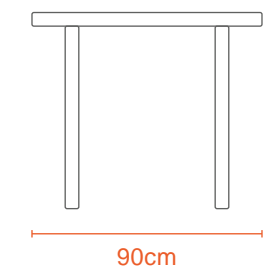
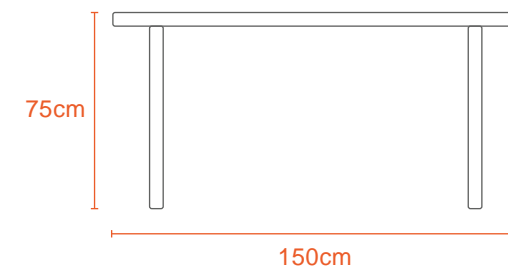

13Kg



Polypropylene

JAVA

LOW COFFEE TABLE

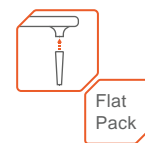
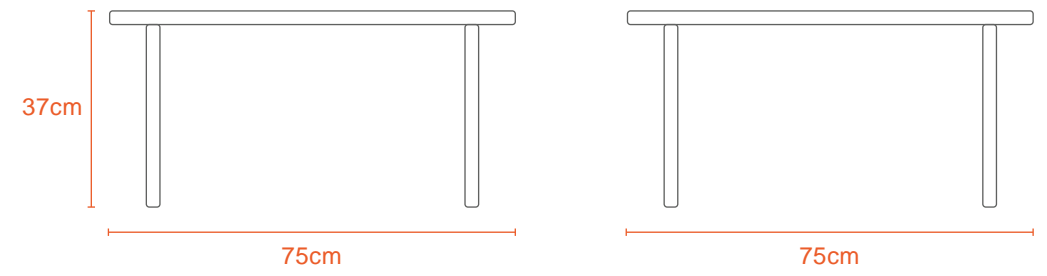

LEISURE



Kg

1.8Kg



Polypropylene

TABLE BASICS



ROUND

DINING TABLE

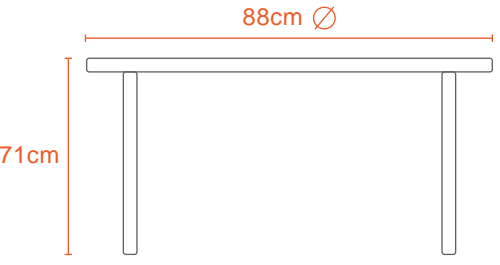



Kg
5Kg

Polypropylene

OVAL

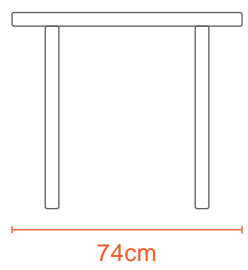
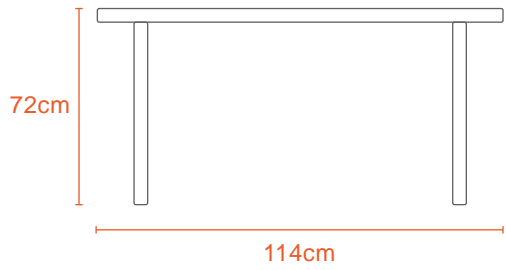
DINING TABLE



Kg
5.4Kg

Polypropylene

COFFEE TABLE

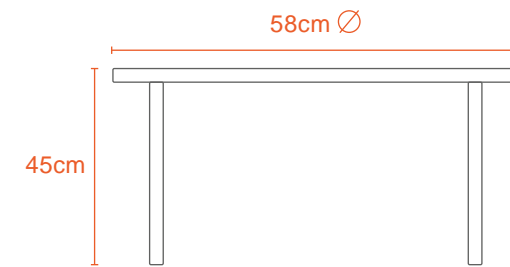



Contact Us

Factory:

Phoenix Industries Ltd
Industrial Zone East,
Makandura, Gonawila,
Sri Lanka.

Tel: +94 (0) 777 889 999

Flagship Store:

Phoenix Showroom
445 Negombo Road,
Welisara,
Sri Lanka.

Tel: +94 (0) 773 951 241 / 773 124 745

[#DesignedForLife](#)

www.phoenix.lk

