

PHOENIX

Storage &
Organization

2024



**THE
REVOLUTION
DOES NOT
STOP!**

OUR STORY

The journey of Phoenix begins in **1976**, when an advertisement in the newspaper showcased the sale of a plastic factory. The dying embers of the machinery piqued an interest in Mr Omar. He took his son to see the injection molding factory, something neither had ever seen before. Mr. Omar's vision always led him toward the new and exciting. After playfully bidding, they acquired not just a factory, but a lifelong business and passion.

As the machines got refurbished, and other challenges were tackled, a vision for a new company emerged. The once dilapidated factory became a household brand, known and adored by every Sri Lankan.

Like a phoenix rising from its ashes, the company became a hotspot for entrepreneurial vision. It made many valuable partnerships along the way, which have been key contributors to the company's rise today. With over 40 years of industrial experience, Phoenix has expanded exponentially.

For the Omar family, Phoenix has been a guiding light; a springboard for many future successes, ventures and adventures. Phoenix is about resurgence and resilience.

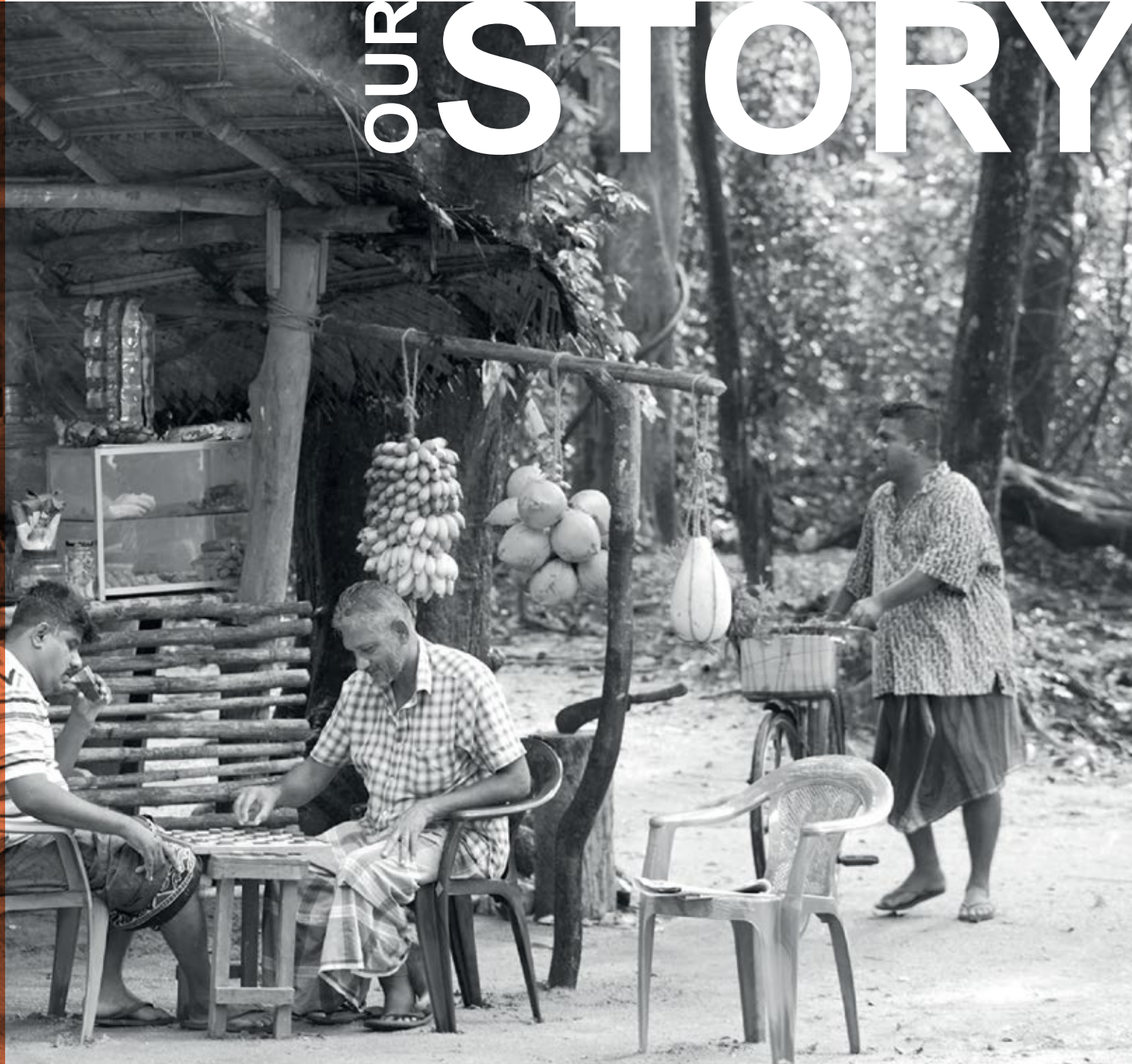

FOR DESIGNED LIFE

Phoenix lives for you

Our purpose is to make every moment of your life practical, smart, seamless and beautiful. We imagine, create and manufacture products envisioning what can give you the most trust, comfort and support - everything you would look for in a life partner! Look around, and you'll see we're right there with you. We are a part of your life - we design for life.



CONTENT

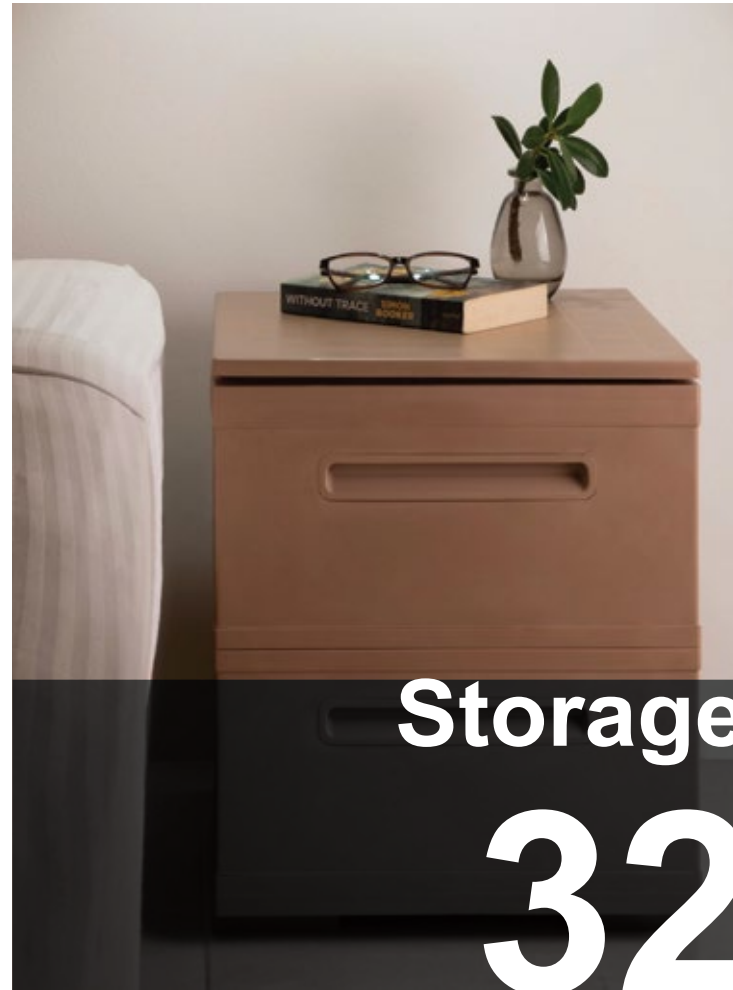



NEW WIN

WAVE



VE





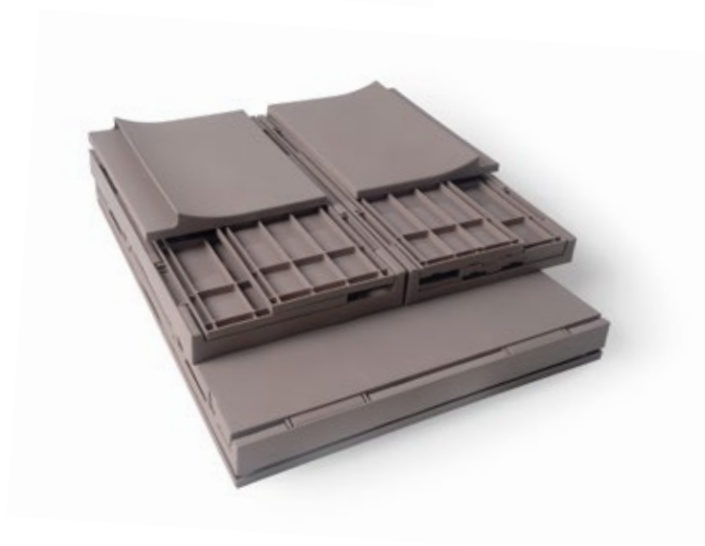
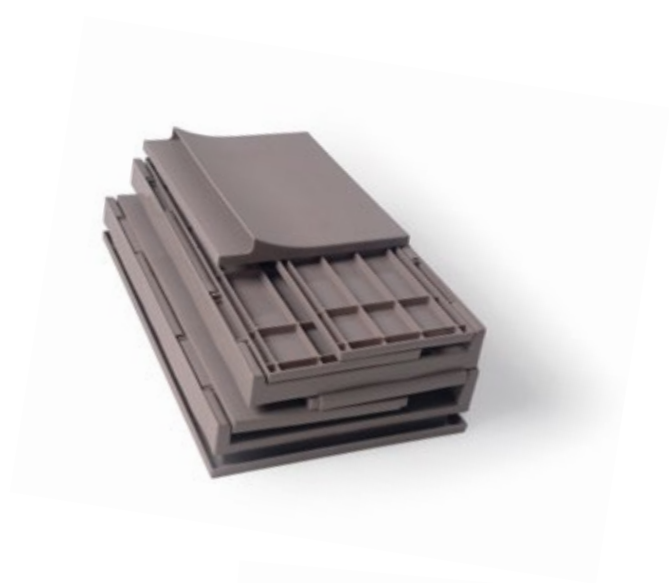



WAVE

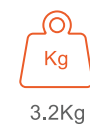
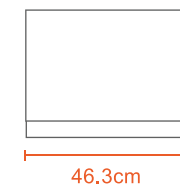
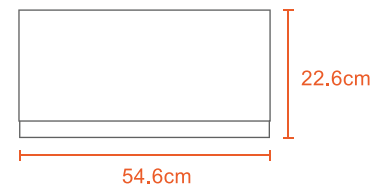

WAVE

TWIN

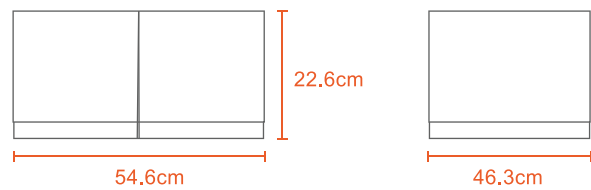

WAVE

JR

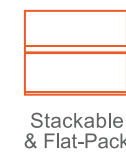
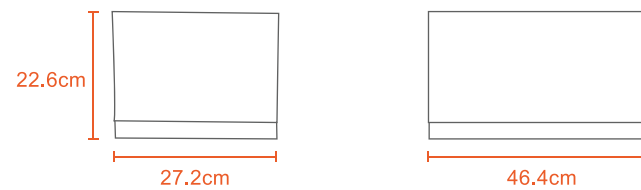



STORAGE BOXES





40L STORAGE BOX

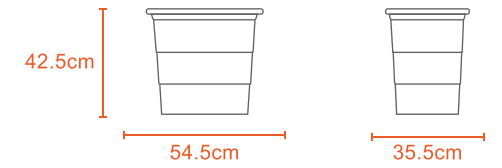
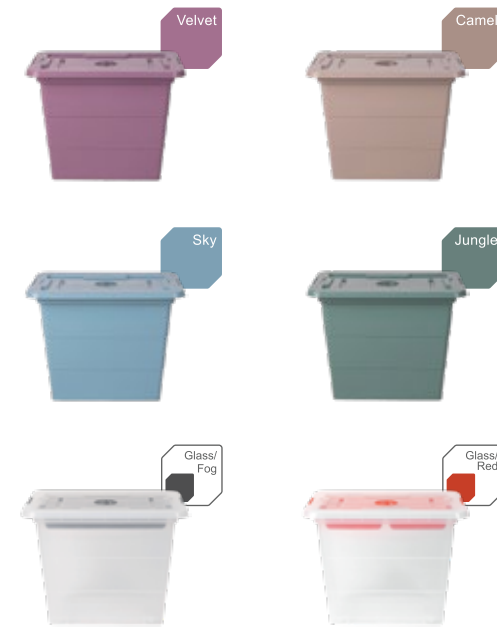

100L STORAGE BOX

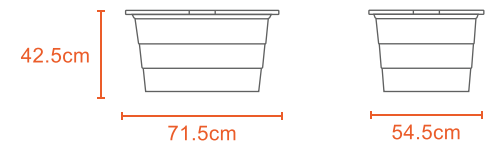



TRAY

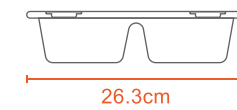
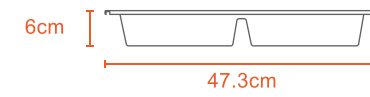

0.4Kg



Polypropylene



MARKETING BASKET

COCO

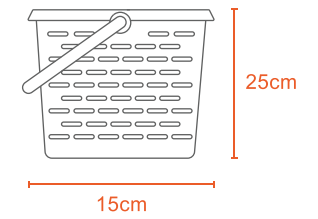
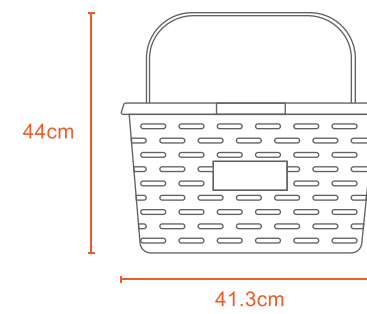

Kg
0.9Kg

Polypropylene

STORAGE



When life takes you to unexpected places, you crave a home. Your belongings deserve to call a place home too. An aesthetic base from where you can summon your everyday items without any effort. Our practical storage solutions are designed to be functional and dependable. Let us do the work for you. Experience a life without clutter and add a little more space into your surroundings.

GRID CLOSET

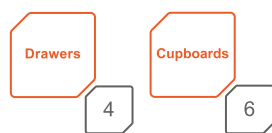
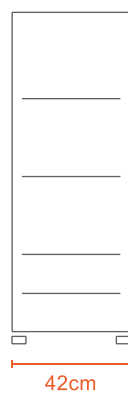
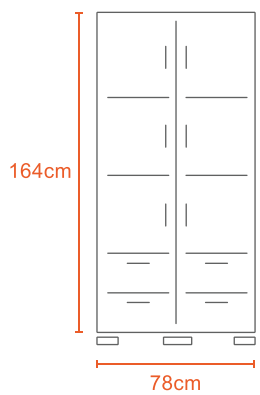

with or without locks

26Kg

Polypropylene

GRID MATE

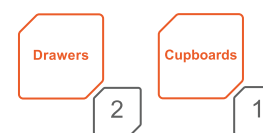
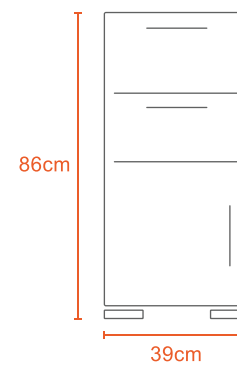

8Kg

Polypropylene

GRID FILE



Beige



Cream



Gray

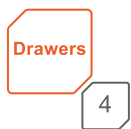
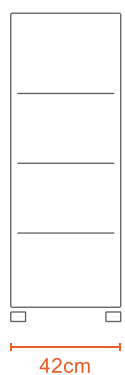
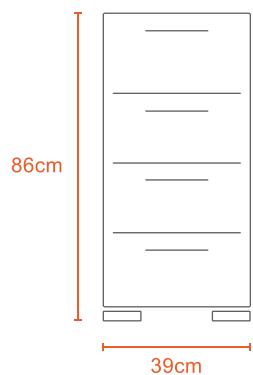

GRID TWIN



Beige



Cream



Gray

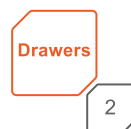
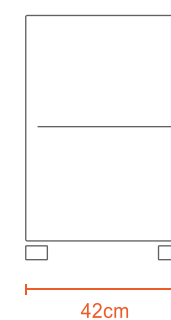
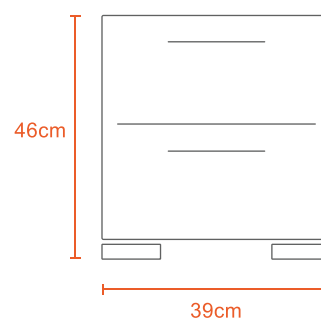

GRID HOME



Beige



Cream



Gray

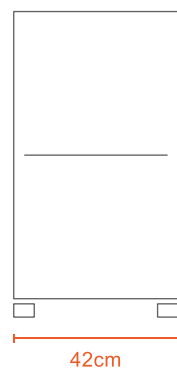
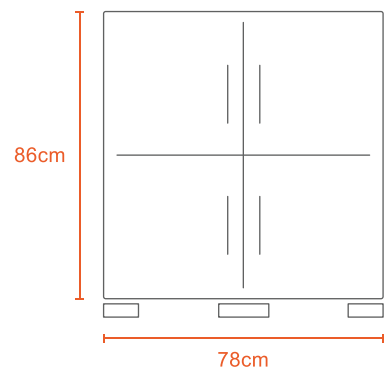

GRID POINT



Beige



Cream



Gray

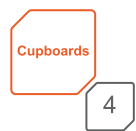
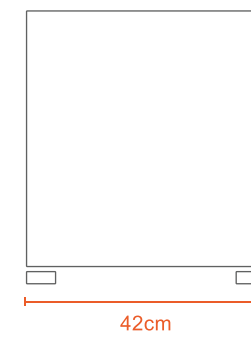
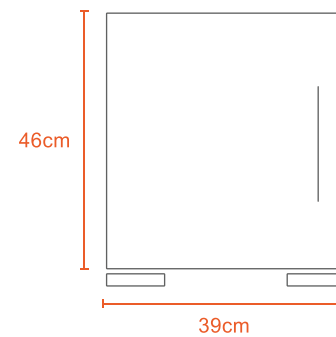

Cupboards

4



Kg

12Kg



Polypropylene

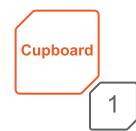

Cupboard

1



with or without locks



Kg

4Kg



Polypropylene

DRAWER

SMALL

4PCS

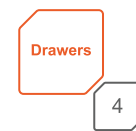
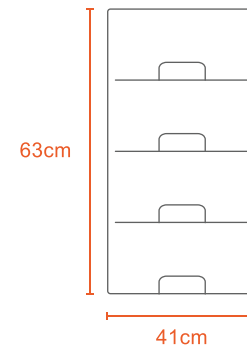

DRAWER MEDIUM 4PCS

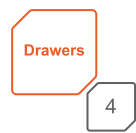
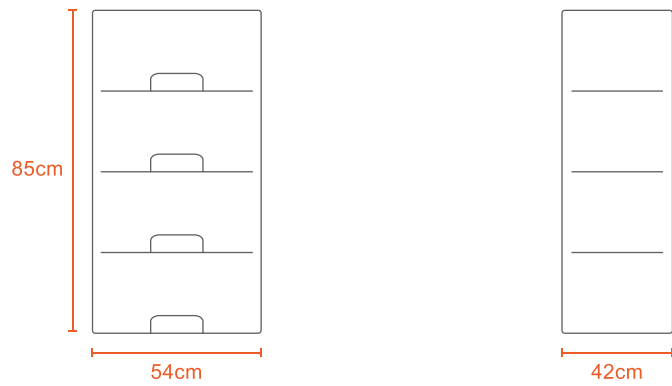

DRAWER MEDIUM 6PCS

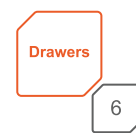
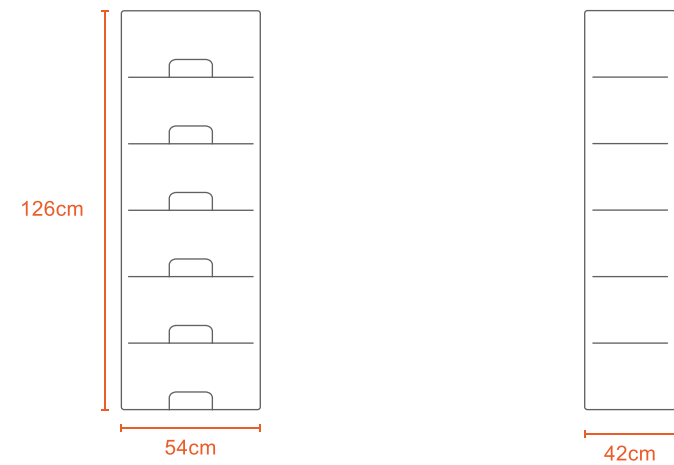



ORGANIZATION

No space is untidy when every item has a place of its own. Untangle yourself from daily worries by delving into our compact solutions. We provide a unique home for every single one of your belongings. You could be miles apart, but with our organization containers, you will know where everything is. Never lose anything ever again, but still find a joy in bringing out what you already own.

FLEX SHOE ORGANIZER

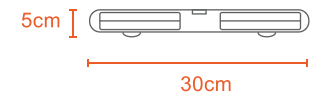
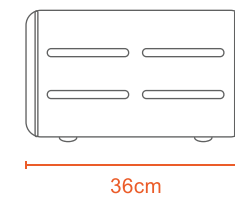
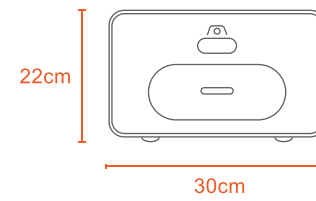

1.2Kg



Polypropylene



Stackable
& Flat-Pack

SHOE RACK

6 LAYERS

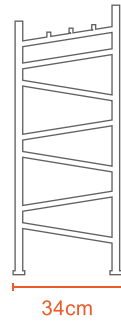
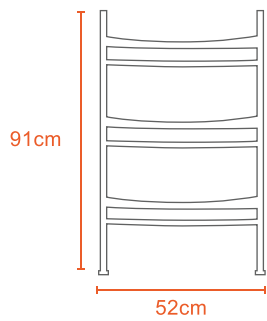

Layers
6

Kg
3Kg

Polypropylene

SHOE RACK

4 LAYERS

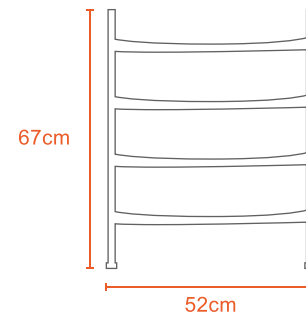

Layers
4

Kg
2Kg

Polypropylene

STORAGE BOXES



5L STORAGE BOX

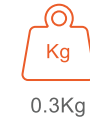
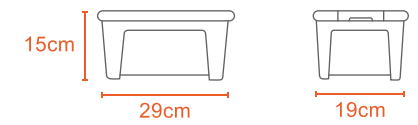

10L STORAGE BOX

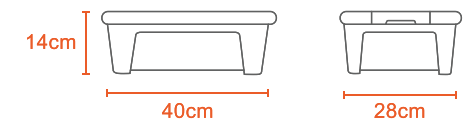

20L STORAGE BOX

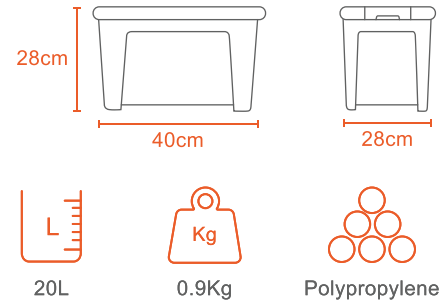

65L STORAGE BOX

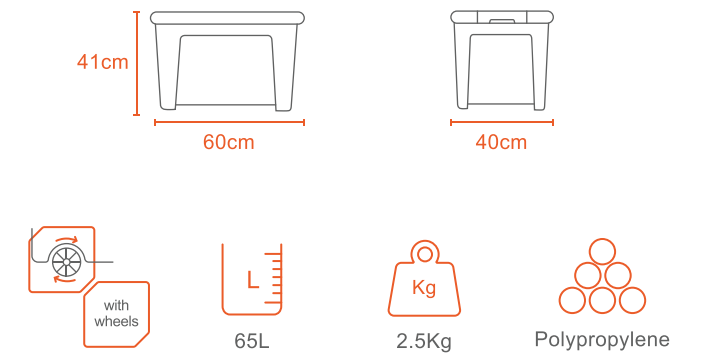

30L STORAGE BOX

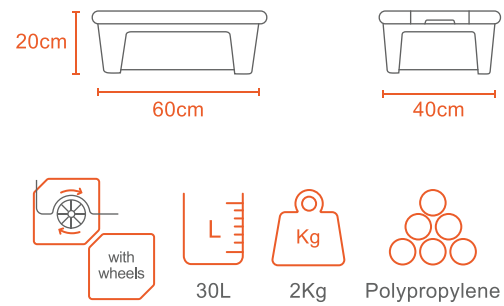

130L STORAGE BOX

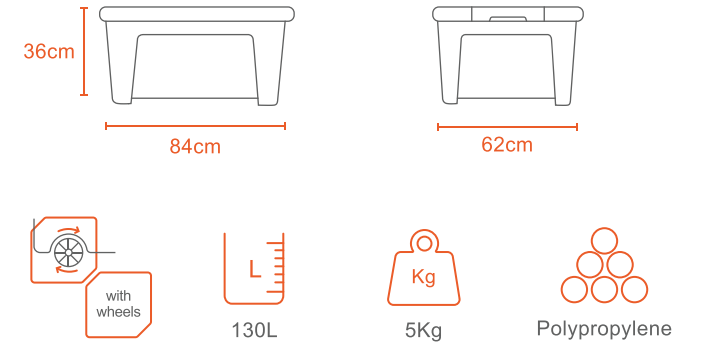
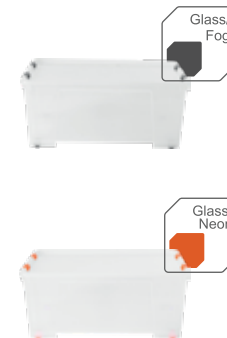

45L STORAGE BOX

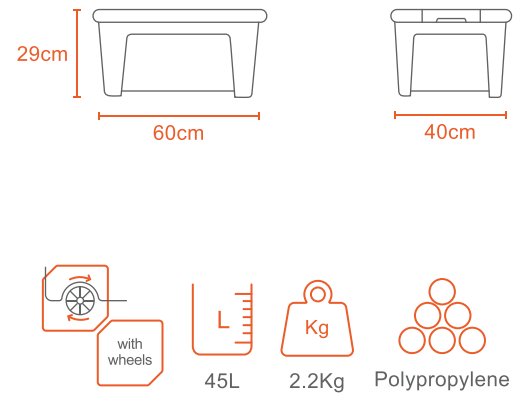
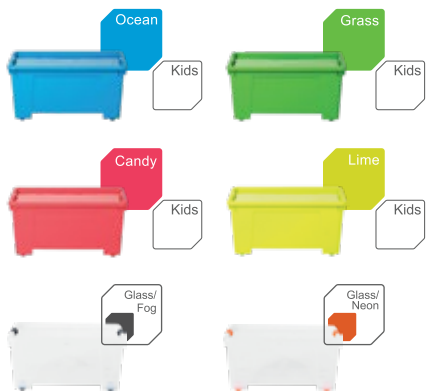

UNDER BED STORAGE BOX

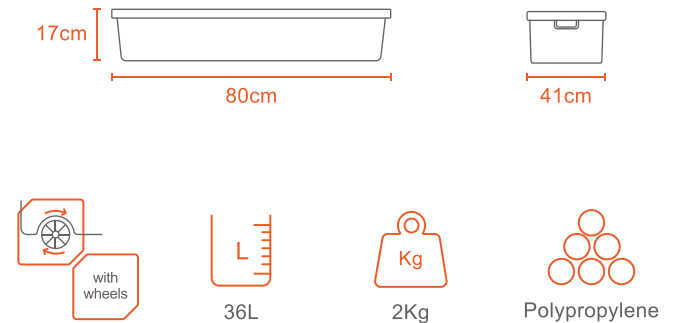

DECO BOXES



10L DECO BOX

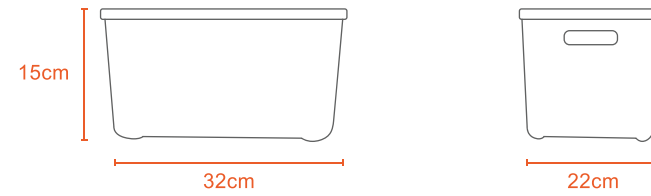
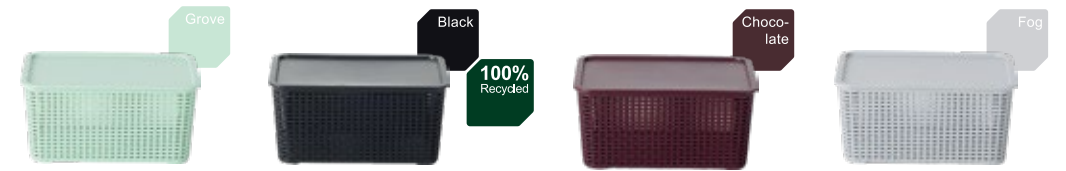

25L DECO BOX

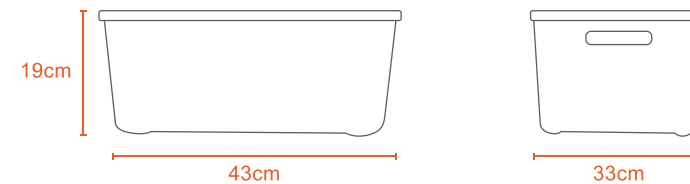

GO

ORGANIZED



DAINTY

MARKETING BASKET

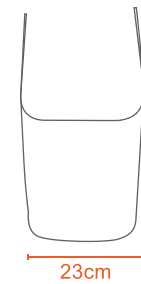
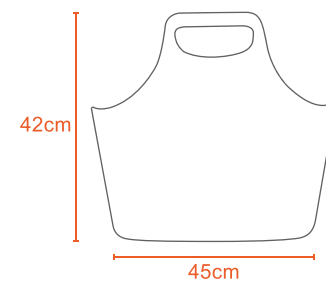
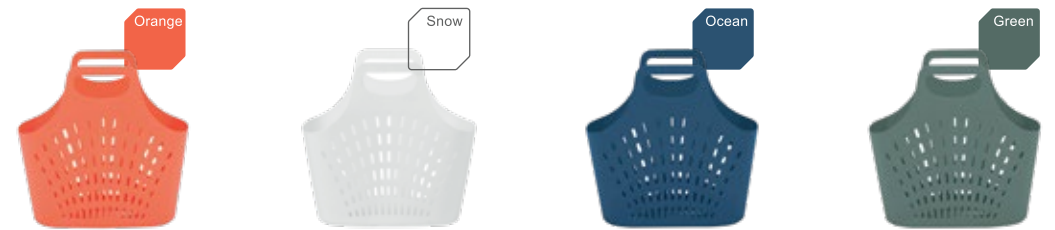

0.6Kg



Polyethylene

LAVINYA

MARKETING BASKET

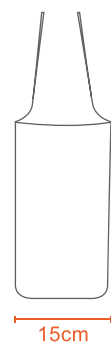
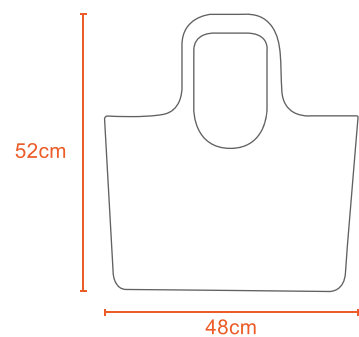

0.7Kg



Polyethylene

OVVAL

MARKETING BASKET

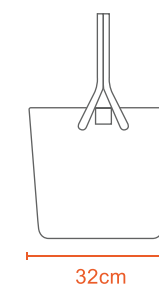
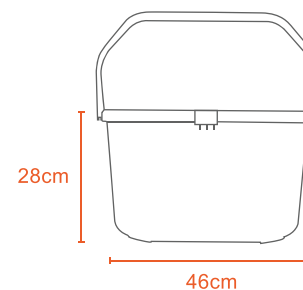

0.9Kg



Polypropylene

PAULS FAMILY





15L PAIL

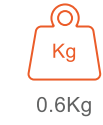
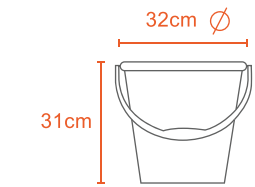

5L PAIL

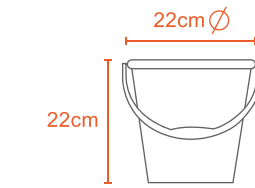

18L PAIL

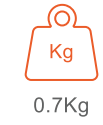
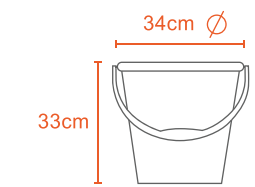

10L PAIL

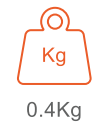
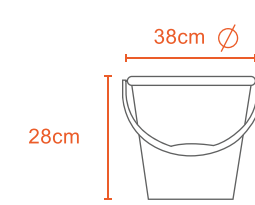

25L PAIL

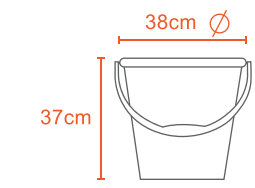

Contact Us

Phoenix Showrooms:

Welisara

No. 445, Negombo Road, Welisara,
Sri Lanka.
Tel: +94 (0) 77 312 4745

Panadura

No. 12, Mahanama Road, Panadura,
Sri Lanka.
Tel: +94 (0) 74 138 8058

Battaramulla

No. 260/1, Pannipitiya Road, Pelawatta,
Battaramulla, Sri Lanka.
Tel: +94 (0) 11 254 9971 / 77 494 3659 / 71 525 7154

#DesignedForLife



www.phoenix.lk





FOR **DESIGNED**
LIFE